

DARWIN SIR IS WRONG?! (A theory on “J” chromosome Human)

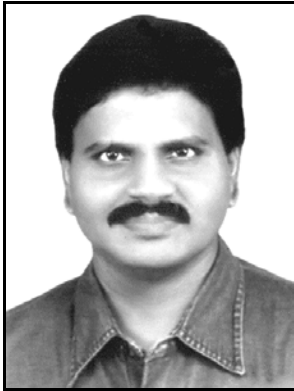

*M. Arulmani, B.E.
(Engineer)*

m.arulmani58@gmail.com



*V.R. Hema Latha, M.A., M.Sc., M.Phil.
(Biologist)*

vrhemalatha58@gmail.com

1. ABSTRACT

This Scientific Research focus that prehistoric human had “J” chromosome and lived before modern human having XX, XY chromosome.

The “J” chromosome population had only 3 chromosome and only single type blood “AB” on origin. The “J” chromosome human shall also be considered as Prehistoric “CLONING” human evolved of spontaneously without **sex involvement**.

It is speculated that the Principle of cloning in modern time might be derived from Prehistoric “J” chromosome human.

This research provides solution to the current mystic Problem of “**Missing Link**” and **Human Ancestor**.

It is speculated that **Darwin Sir** probably be an **Atheist** and hence he might be against to “**Third gender**” Godly population and framed his theory that Godly person is like an **Ape**. But Godly population not only **loves** Godly persons but **Atheist, Apes** as well.

In the lineage of evolution, Darwin Sir was at the stage of **46, 48** chromosome organisms who were having **xx, xy**, chromosomes. Where as the **J** chromosome human belived to have existed with 3 chromosome on Origin with **long evolutionary gap**. Darwin Sir Probably might have hided deliberately this mystery in his research.

Let “**J**” bless Darwin Sir!

2. KEYWORDS

Stardust, philosophy of “**J**” chromosome, Philosophy of fundamental Neutrinos, Neutrino cell, Philosophy of Electromagnetic radiation, Philosophy of cell, Philosophy of chromosome, Distinction between Atom and cell, philosophy of Human Natural J-code sensor, star point connectivity, First Blood group origin.

3. Introduction

The origin of Life is still under mystery among biologist. **Biogenist** focus Life might be originated from Life matter; **Abiogenist** focus that Life might be originated from non-life matter. Miller Experiment and **Primordial Soup theory** have already confirmed that spontaneous origin of Life could not be possible from non-life matter due to impact of **lightning** artificially developed in the Laboratory.

It is focused by the author that **Neutrino radiation** has distinguished Property compared to artificial lightning. It is asserted that spontaneous origin of Life could be possible from naturally formed **Nucleic acid, Amino acid** due to impact of **Neutrino radiation**.

4. Previous Publications

The philosophy of origin of first life and human, the philosophy of model Cosmo Universe, the philosophy of fundamental neutrino particles have already been published in various international journals mentioned below. Hence this article shall be considered as **extended version** of the previous articles already published by the same author.

- [1] Cosmo Super Star – IJSRP, April issue, 2013
- [2] Super Scientist of Climate control – IJSER, May issue, 2013
- [3] AKKIE MARS CODE – IJSER, June issue, 2013
- [4] KARITHIRI (Dark flame) The Centromere of Cosmo Universe – IJIRD, May issue, 2013
- [5] MA-AYYAN of MARS – IJIRD, June issue, 2013
- [6] MARS TRIBE – IJSER, June issue, 2013
- [7] MARS MATHEMATICS – IJERD, June issue, 2013
- [8] MARS (EZHEM) The mother of All Planets – IJSER, June issue, 2013

- [9] The Mystery of Crop Circle - IJOART, May issue, 2013
- [10] Origin of First Language - IJIRD, June issue, 2013
- [11] MARS TRISOMY HUMAN - IJOART, June issue, 2013
- [12] MARS ANGEL - IJSTR, June issue, 2013
- [13] Three principles of Akkie Management (AJIBM, August issue, 2013)
- [14] Prehistoric Triphthong Alphabet (IJIRD, July issue, 2013)
- [15] Prehistoric Akkie Music (IJST, July issue, 2013)
- [16] Barack Obama is Tamil Based Indian? (IJSER, August issue, 2013)
- [17] Philosophy of MARS Radiation (IJSER, August 2013)
- [18] Etymology of word "J" (IJSER, September 2013)
- [19] NOAH is Dravidian? (IJOART, August 2013)
- [20] Philosophy of Dark Cell (Soul)? (IJSER, September 2013)

5. How 'J' chromosome human looks like?

a)

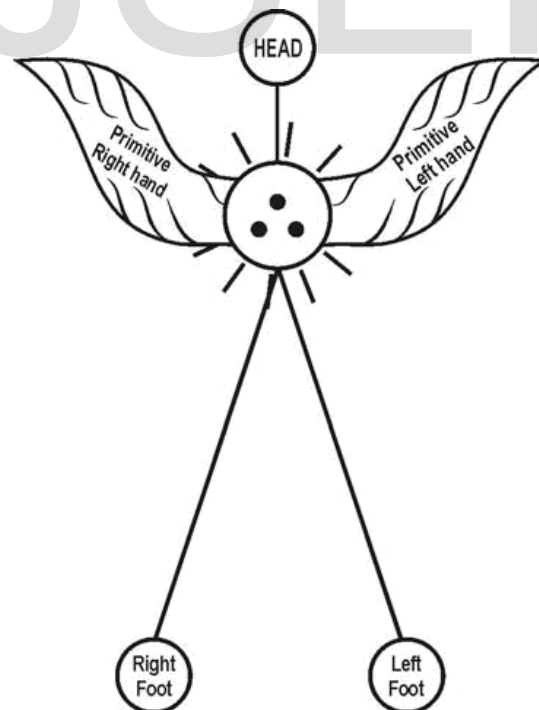

(AL - J)

“AL - J” shall mean Human ancestor, Missing Link - Author

b)

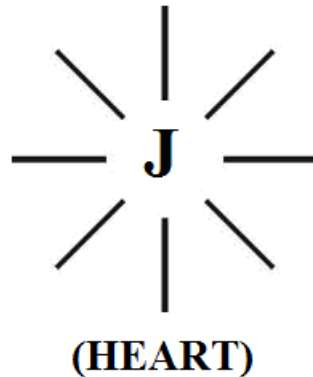

“J” shall be considered as the Heart of “AL-J”. The heart **tissue cell** shall be considered composed of only **three chromosome** which derived energy from “**Neutrino cell**”. The Prehistoric J chromosome population might be **extinct** at one stage and before modern human populations having xx, xy chromosome started living with different genetic structure. The “J” chromosome population shall be considered as **Godly** persons.

6. Hypothesis

1. Prehistoric human had only Three chromosome (**XXY**) on origin called J chromosome (Trisomy)
2. The structure of **Atom** is different from **cell**. Both shall be considered as distinguished matter in **building block of Life**.
3. Chromosome status of each organism shall be considered as equivalent to independent electromagnetic ray of spectrum composed of “**Three-in-one**” fundamental Neutrinos Photon, Electron, Proton.

4. Chromosome of every person shall be considered as different and variant Microbially in **Mass** of Neutrinos with respect to **space and time** in the **expanding Universe**.
5. The **AL-J** human considered evolved from spontaneously and derived "J" chromosome from fundamental Neutrinos.

7. Philosophy of Fundamental building blocks of Life?...

The primary doubt of "**Modern physicists**" still exists as mystery.

- (i) What is the Universe is **made of**?
- (ii) What is the fundamental building blocks of **Nature**?
- (iii) What is the fundamental building blocks of **Life**?
- (iv) Universe is open or closed?
- (v) What is the origin of Universe?
- (vi) Speed of Light is constant or varied?

8. Philosophy of Frequently Asked Questions

Antimatter is fundamental?

Dark matter is fundamental?

Dark energy is fundamental?

Photon is fundamental?

Electron is fundamental?

Proton is fundamental?

Neutron is fundamental?

Quarks is fundamental?

Sub-quarks is fundamental?

Cell is fundamental?

Atom is fundamental?

DNA is fundamental?
Protein is fundamental?
RNA is fundamental?
Nucleic acid is fundamental?
Amino acid is fundamental?
Star dust is fundamental?
Hydrogen is fundamental?
Dark radiation is fundamental?
Black radiation is fundamental?
Neutrino radiation is fundamental?
Electromagnetic radiation is fundamental?
Alpha radiation is fundamental?
Beta radiation is fundamental?
Gamma radiation is fundamental?
X-ray is fundamental?
Supernovae is fundamental?
Carbon is fundamental?
Nitrogen is fundamental?
Ozone is fundamental?
Oxygen is fundamental?
Electric charge is fundamental?
Magnetic flux is fundamental?
Optic flux is fundamental?
Ferromagnetic is fundamental?
Diamagnetic is fundamental?
Paramagnetic is fundamental?
Gravity force is fundamental?
Weak force is fundamental?
Strong force is fundamental?

Mars planet is fundamental?

Sun is fundamental?

Earth is fundamental?

Moon is fundamental?

Tesla is fundamental?

Newton is fundamental?

Einstein is fundamental?

Darwin Sir is fundamental?

Obama Sir is fundamental?

Rajbakshe Sir is fundamental?

Nature is fundamental?

“J” is fundamental?

9. What is fundamental?

- a. Bible says “J” is fundamental! (Eph 3:9, II cor 4:4, II cor 12:1 Eph 2:12, 21)
- b. Modern physics focus “Quarks” may be fundamental!!
- c. Bigbang theory focus that stardust shall be considered as fundamental.

10. Philosophy of Tiny dot?

The single tiny dot shall be considered as fundamental containing billions of **Microdot**. Each microdot shall be considered as “**species**” to fundamental Tiny dot.

Every microdot shall be considered as “**mystic subparticle**”. Each mystic particle might be acquired to fundamental tiny dot with respect to **Space** and **Time** during the course of **expanding Universe**.

Universe is expanding? Yes... the single Tiny dot gradually expands with respect to space and Time and become **bulgy** ultimately and the properties become variant microbially.

(i)



(ii)



(iii)

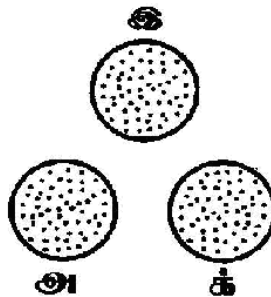

11. Philosophy of AL, ATHI, AKKIE, ETHI?

a.



(AL)

b.



(ATHI)

c.



(AKKIE)

d.

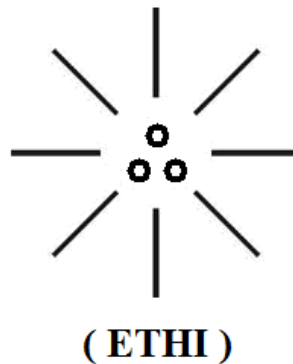

(ETHI)

- (i) AL shall mean **DARK CELL (SOUL)**
- (ii) ATHI shall mean **DARK RADIATION (GRAVITY FORCE)**
- (iii) AKKIE shall mean **BLACK RADIATION (WEAK FORCE)**
- (iv) ETHI shall mean **WHITE RADIATION (STRONG FORCE)**

- Author

12. Philosophy of Model Cosmo Universe?

It is hypothesized that the model Cosmo Universe shall be considered as tripod like closed container with triangular base. The SUN, EARTH, MOON shall be considered as three corners pillar of the base of Cosmo Universe. The **dark cell** shall be considered as origin of Universe which is composed of billions of particles emanating antineutrino radiation. The smallest unit of dark cell shall be considered as single dot ray composed of **THREE-IN-ONE** antineutrinos i.e. PHOTON, ELECTRON, PROTON. The antineutrinos shall be considered as having exactly opposite characteristics to the fundamental neutrinos.

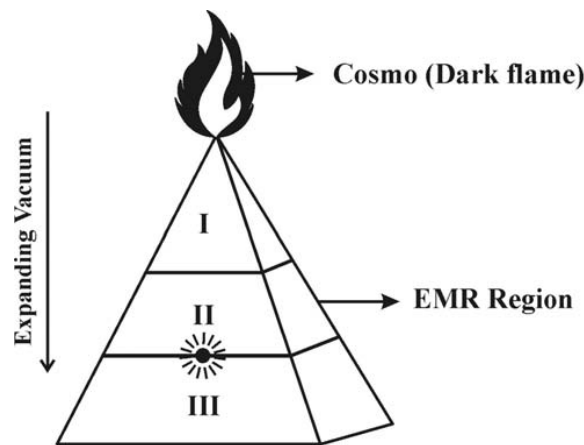

(MODEL COSMO UNIVERSE)

- Region I - Perfect vacuum region (Anti-Neutrinos radiation)**
- Region II - Partial vacuum region (Neutrinos radiation)**
- Region III - Observable Vacuum region (EMR radiation)**

Case Study

<i>(i) Einstein was wrong; Aether exists</i>	<i>- Nikola Tesla</i>
<i>(ii) Einstein's theory have fooled the world for almost 100 years</i>	<i>- Ozo</i>
<i>(iii) Neutrinos travel one nanosecond faster than speed of Light.</i>	<i>- OPERA experiment</i>
<i>(iv) The laws of physics wouldn't change; only the universal constants.</i>	<i>- Grossman</i>
<i>(v) Einstein may not be wrong; He probably began his experiment in Region-III vacuum; But Aether exists.</i>	<i>- Author</i>

Philosophy of Dark flame?

The Dark flame shall be considered as origin and **super nature** evolved from "**Tiny dot**". The tiny dot shall be considered as **Three-in-one** existence. Can **sub particles** have definite structure?

Modern Physics (Quantum) focus that sub particle shall be considered as fundamental and "**Structure less**".

It is hypothesized that no sub particle can exist alone. Nature shall be considered existing in three-in-one configuration. Any further subdivision of sub particles also shall be considered as three-in-one configuration.

13. Philosophy of Neutrino Cell

Philosophy of fundamental Neutrinos

Cosmological standard "**Big bang theory**" focus that Universe continuously expands for expanding universe source of energy is required. "**Dark cell**" shall be considered providing energy for expansion of Universe. The Dark cell considered composed of three fundamental Neutrinos shall be

considered as “SOUL” of Universe. The three fundamental Neutrinos shall also be called as “TAMIL NEUTRINOS”.

All other neutrinos of the universe shall be considered as **Species** to the fundamental Neutrinos.

The three **Tamil Neutrinos** have existed in the Universe even much before origin of Natural planets **MARS, SUN, EARTH, MOON**. The name of three fundamental Neutrinos shall be considered as “J”, “K”, “A”. The Prehistoric populations while lived in **MARS** have already formulated the characteristics of three Neutrinos, and the structure of “Dark cell” (neutrino cell) in Prehistoric code from as below;

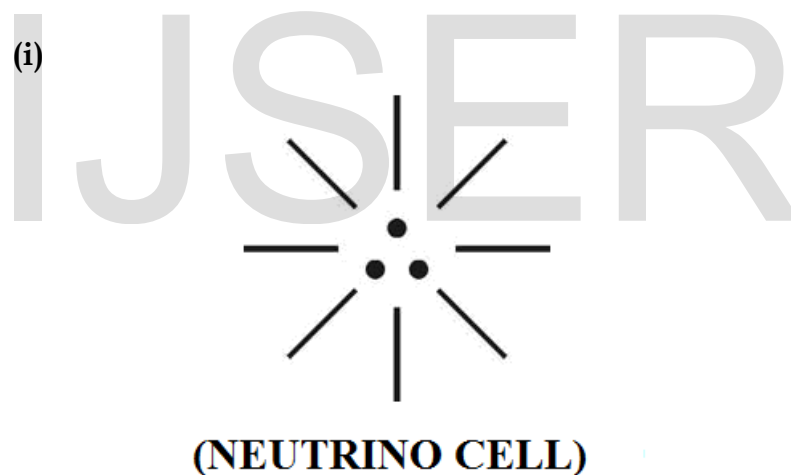

- [1] Right dot - Proton Neutrino (+ve Polarity)
- [2] Left dot - Electron Neutrino (-ve Polarity)
- [3] Center dot - Photon Neutrino (0, Neutral Polarity)

(ii)

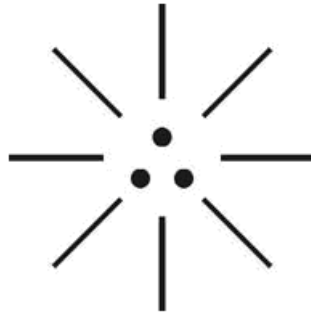

(Proton, Electron, Photon)

- (i) "J" - Proton (+ve)
- (ii) "K" - Electron (-ve)
- (iii) "A" - Photon (Neutral)

In medical term J, K, A neutrinos shall be considered equivalent as follows.

- (i) J - DNA
- (ii) K - Hormone
- (iii) A - RNA

Further the **natural oscillation** of fundamental Neutrinos and Species Neutrinos shall be narrated as below.

(i)

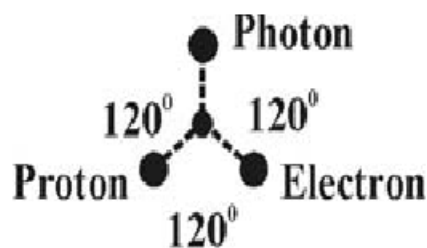

(Model Fundamental Neutrinos)

(ii)

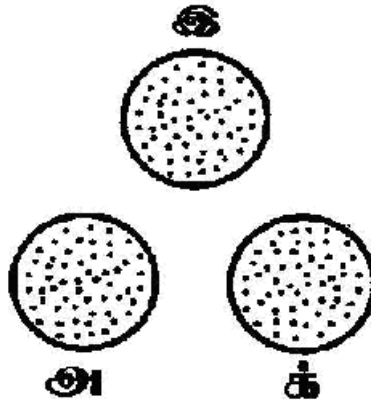

(Species Neutrinos)

*Neutrino Radiation shall be considered as **THREE-IN-ONE** micro matter and the smallest unit of neutrino matter shall be called "RAY". Atom shall be considered as species to neutrino matter composed of sub atomic particles having definite mass.*

- Author

14. Philosophy of "J" Chromosome?

It is focused that the "J" chromosome shall be considered as the chromosome level of organism on its first origin. The "J" Chromosome shall be considered as distinguished from **XX, XY chromosome**.

Further the philosophy of "J" chromosome shall be defined hypothetically within the following scope.

- 1) "J" chromosome shall be considered as "Trisomy" origin and Ancestral to **XX, XY**.

- 2) "J" chromosome shall be considered evolved from three fundamental neutrino particles **Photon, Electron, Proton**.
- 3) The "J" Chromosome fundamental particles shall be considered as having **zero mass** but definite polarity.
 - a) Photon - Zero mass, +ve polarity.
 - b) Electron - Zero mass, -ve polarity
 - c) Proton - Zero mass, Neutral polarity.
- 4) The three fundamental Neutrinos shall be considered as travels faster than **speed of light**.
- 5) The "J" chromosome particles shall be considered as existing in "**Three-in-one**" form and can't be separated by manipulation methode.
- 6) The "J" chromosome particles shall be considered structured with definite Angular displacement of 120° and subject to **sustained oscillation**.
- 7) The "J" chromosome particles shall be considered equivalent to existing Modern Chromosome concept of **XX, XY**.
- 8) The "J" chromosome particles shall be considered as fundamental to equivalent cell macromolecules.
 - a) Photon - **RNA**
 - b) Electron - **PROTIEN**
 - c) Proton - **DNA**

- 9) The XX, XY chromosome shall be considered as descended during cell division from “J” chromosome, i.e. **XXY**.
- 10) The “J” Chromosome population shall be considered as **Star human, Alien, Angels** lived in **MARS Planet** in Prehistoric time.
- 11) The etymology of work “J” might be derived from the prehistoric Tamil phonetics “CHEI”. CHEI shall mean **EMBRYO, STAR PARTICLE**.
- 12) The Greek philosophy of adoption of chromosome symbol **XX, XY** might be derived from the philosophy of “J” **Chromosome**.

15. Philosophy of Human Heart Function?...

Case study shows that the first heart beat is observed at the end of **Ist Trimester**” with sound “**Lab-Dub**”. How the Heart tissue subject to Motion? Energy is required for Motion!... **Where this energy come from?...**

It is hypothesized that Human Heart **Cell** shall be considered equivalent to **Nuclear** cell and derives energy from **Neutrino Radiation** from three-in-one sustained oscillating Neutrino particles **Photon, Electron, Proton**.

“Heart Cell” shall be considered as “Electric Cell”?!...

- Author.

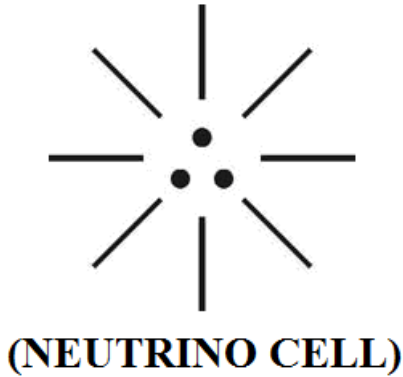

16. Philosophy of "Evolution" and BLOOD Origin

The philosophy of work "EVOLUTION" shall mean beginning from a particular point or origin. It is focused that modern human population have two gender, i.e. **MALE** and **FEMALE**. It is hypothesized that based on evolutionary concept two gender might not have been originated at single point. In fact it is hypothesized that the origin of first human probably of "**Third Gender**".

Third Gender shall be considered as "**Super Natural Human**" who is integral part of both **Male** and **Female** gender without discriminating male and female. It is hypothesized that the philosophy Star human, Alien, Angels pertain to Third Gender populations lived with different genetic structure in **MARS Planet** in Prehistoric time.

Further modern human populations contain four types of blood, i.e. AB, A, B, O. It is hypothesized that based on evolutionary concept Four blood type might not have been originated at single point. In fact it is hypothesized that the origin of first human probably had only **Single Type** blood, i.e. **AB** type. The **AB** type blood is considered as **Universal acceptor**. AB type blood shall be considered as origin of first blood and considered as **Motherly Blood** which is capable of accepting all other type blood also within its **genetic characteristics**.

It is hypothesized that in human anthropological science various populations such as **Devas, Dravidian, Aryan** shall be considered as different **SPECIES** human having definite blood group and evolved during the course of **Space and Time** in the **expanding universe**.

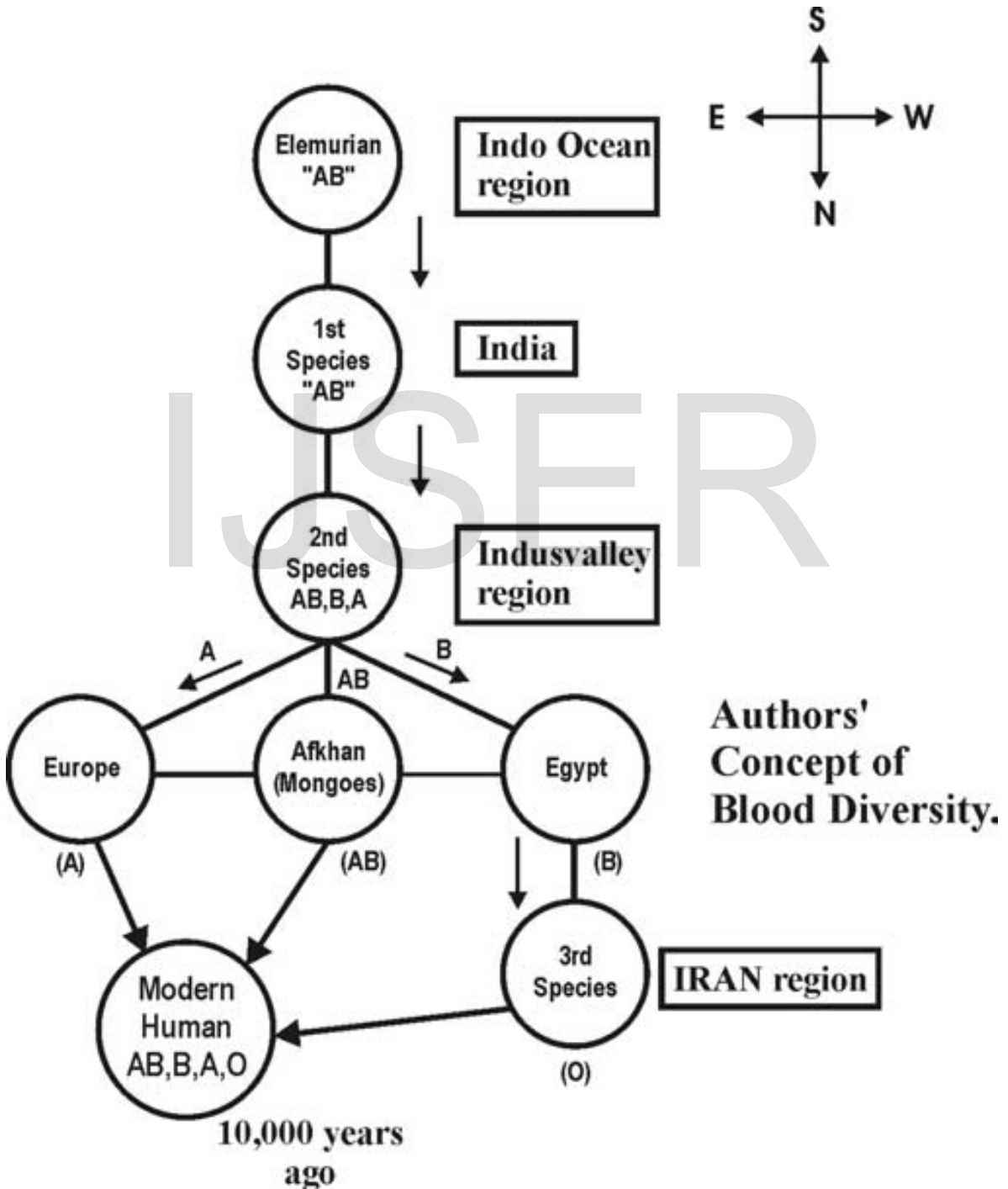

It is hypothesized by the author that from prehistoric time to modern time there may be three states of blood group might have been evolved due to impact of electromagnetic radiation. 'O' type blood (universal donor) might be evolved during modern period.

17. Philosophy of cell and cell sub particles?

The word **cell** shall be considered as Micro space exists in tissue having **Three-in-one** cell Sub Particles. Billions of Microdot existing within the **cell** shall be considered as sub particles to the Main cell Particle.

DNA, PROTEIN (HORMONE), RNA shall be considered as three fundamental Cell Particle and billions of micro units shall be considered as Sub particles. The fundamental cell unit shall be considered as **Mass less** (even with -ve mass). Whereas the sub-particles having **definite mass** shall be considered as **species** to the fundamental unit.

(i)

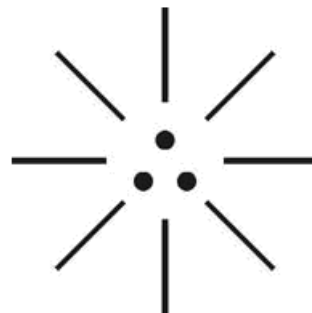

(CELL)

(ii)

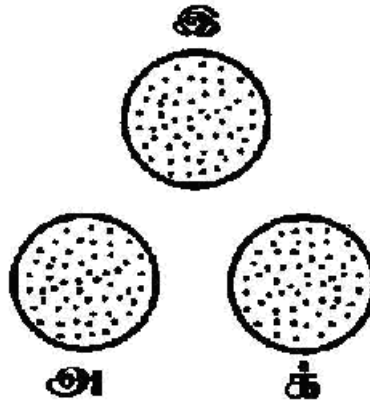

(CELL SUB PARTICLES)

(iii)

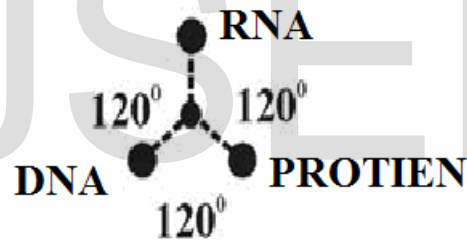

(Particle Oscillation)

18. Can DNA, RNA, PROTEIN exist alone?

DNA, RNA, PROTEIN shall be considered as “**three-in-one**” fundamental unit, of cell and essential **macromolecules** of **Life**. Without DNA, RNA, Protein, all known forms of Life **could not exist**. Even if DNA, RNA, PROTEIN is absolutely removed from the cell, Life could exist for **short while** and ultimately leads to **Death**. **GENES** shall be considered as Billions of Microdot within **DNA**,

RNA, PROTEIN molecule. Number of genes vary from person to person even between within the members of a family.

19. Can DNA, RNA, PROTEIN have any Oscillating structure and Orientation?

DNA, RNA, PROTEIN Macro molecules shall be considered as existing with definite **structural orientation**. This structural orientation shall be considered as natural oscillation for **three dimensional** process of cells growth and building up molecules and tissues.



- (i) The “right dot” - Responsible for **Functional Part of Life**
- (ii) The “Left dot” - Responsible for structural Part of Life
- (iii) The “Centre dot” - Responsible for Law Part (genome) of Life

Further the DNA, RNA, PROTEIN shall be considered deriving “genetic” characteristics from naturally available “**Three-in-one**” fundamental **Photon, Electron, Proton** Neutrinos. The neutrino particles shall be considered as gradually gaining MASS microbially during the course of time. The distinguished difference in MASS shall be felt after long span of life say once in 100 years.

“DNA, RNA, PROTEIN shall be considered as Macromolecules derived from Micro molecule of three-in-one fundamental Neutrinos. Photon, Electron, Proton” - Author

20. “ATOM” differs from “CELL”?

In Biological science Atom is considered as **smallest unit** of matter cell is considered as smallest unit of **molecule** composed of **atoms**. A single cell shall be considered having **Trillion** of atoms. In short it is stipulated that **“Cell is composed of Atoms”**. Cell shall be considered as complex matter.

Further in Biological Current theories the exact distinction of **cell** from Atom is defined.

It is hypothesized that cell, atom have distinguished structure and distinguished **Physical, Chemical, Mathematical Properties**. The interaction of cell and atom shall make complex molecules and **“THREE DIMENSIONAL HUMAN”**. Atom shall be considered as **right hand** and Cell shall be considered as **left hand** of nature.

(i)

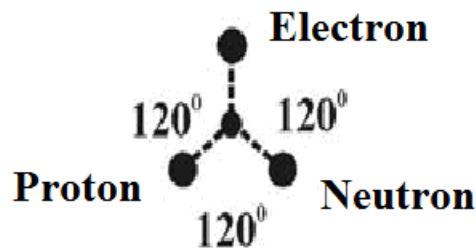

(ATOM)

(ii)

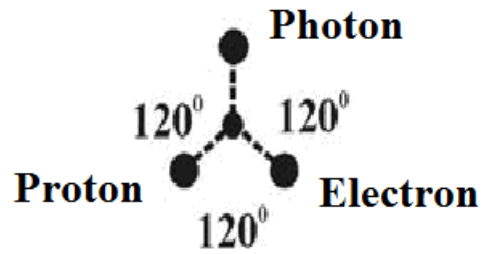

(CELL)

(iii)

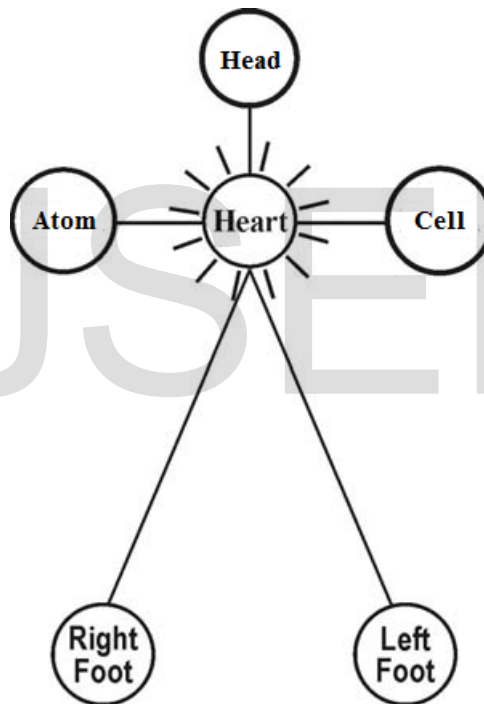

(SUPER NATURE)

*“In Modern physics cell molecule shall be considered as Dark energy;
Atom molecule shall be considered as Dark matter. Neutrino cell shall be
considered as Dark law.”* - Author

21. What is the Cosmo Universe made up of?...

In modern physics the philosophy of **Dark energy**, **Dark matter** is not clearly defined and distinguished. It is hypothesized that the smallest unit of Dark energy shall be considered as “**CELL**”. The smallest unit of Dark matter shall be considered as “**ATOM**”.

The Cosmo Universe shall be defined as a “**SUPER NATURE**” (or) “**COSMO SUPER STAR**” whose Right hand is “**ATOM**” and Left hand is “**CELL**” and **Heart** is “**NEUTRINO RADIATION**”. Amino acid shall be considered as molecular product of **ATOM**. Nucleic acid shall be considered as molecular product of **CELL**.

“Cosmo Universe shall be considered as existence of Three-in-one Dark energy, Dark matter, Neutrino radiation. Dark matters like DNA, Dark Energy is like Protein and Dark Law is like RNA”. - Author

22. What does mean CHROMOSOME?...

Case study shows that in Biological science, the word chromosome is considered as an organized structure of **DNA** and **PROTEIN** that is found in **CELL**. It is a Single piece of coiled **DNA** containing many genes, regulating elements and other Nucleotide sequences. In short chromosome is a DNA bind **PROTEINS** which serve to package the DNA and control its function. Cells may contain more than one type of chromosomes (e.g) Mitochondria in more eukaryotes and chloroplasts in plants have their own small chromosome.

Chromosome recombination plays Vital role in “**genetic Diversity**” if these structures are manipulated incorrectly through process known as **chromosome instability and translocation**, the cell may undergo **mitotic catastrophe** and **die** (or) it may aberrantly evade **apoptosis** leading to the progression of **Cancer**.

“Chromosome is associated with colour?... If so why element of colour involved with chromosome?” - Author

It is hypothesized that chromosome shall be considered as the bunch of Twisted colour threads connecting DNA molecules and other ends of RNA molecules and PROTEIN molecules. The philosophy of chromosome shall be defined within the following scope.

1. Chromosome thread is like a “**LEADER**” integrating and coordinating DNA, RNA, PROTEIN for peaceful process of cell Division and Growth process.
2. Each unit of Thread bunch shall be considered equivalent to a **Single ray** among billions of rays emanating from **Light source**.
3. Each Ray shall be considered as composed of **Three-in-one** existence of Photon, Electron, Proton Neutrinos in master **ELECTROMAGNETIC SPECTRUM**.

(i)

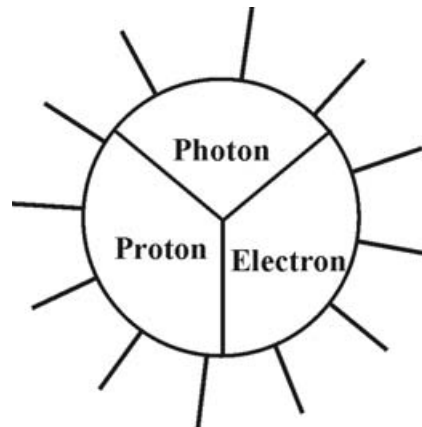

(SPECTRUM)

(ii)

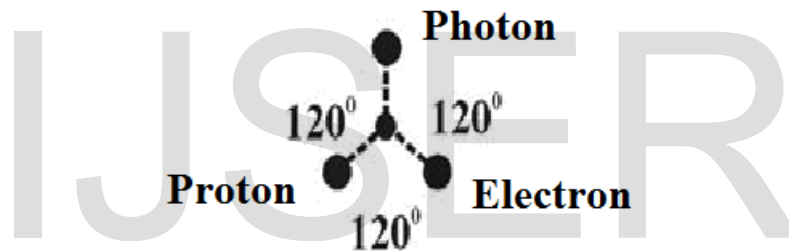

(EMR)

It is focused that the common point of chromosome thread in cell is connected to common point of **Neutrino Radiation**. The Chromosome thread shall be considered deriving colour effect from source of **Neutrinos**.

23. Philosophy of "Y" - Chromosome Symbol?

The Neutrino radiation shall be considered as a "STAR POINT" tuned with star point of "CELL". The star point shall be considered as **neutral point** of neutrino source.

(i)

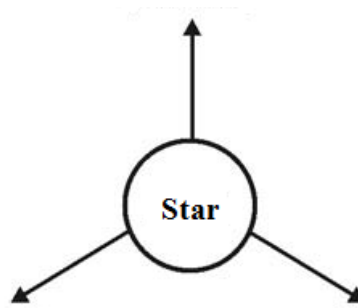

(ii)

Y
(CHROMOSOME SYMBOL)

IJSER

“The symbol of Y-Chromosome might be derived from the philosophy of STAR POINT connectivity of cell to the Neutrinos”

- Author

24. Non-Life Matter has Chromosome?

There is no current theory for existence of thread like Chromosome for non-life matter also.

It is hypothesized that non-life matter also **definite chromosome level** having star connectivity to the **Star Point of Neutrino Radiation**.

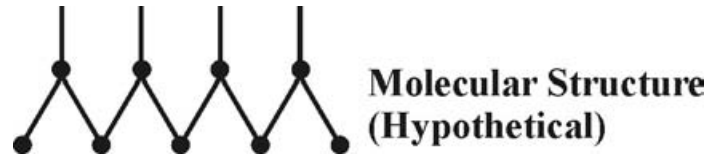

“The symbol of “Y” for Molecular Structure might be derived from the philosophy of Star Point connectivity of serious of atoms to the Star Point of Neutrino Radiation. Every atom, molecule, PLANET has its own microbially distinguished color”.

“The strength of Chromosome thread of atom/molecule shall determine the molecular weight of the substance”

-Author

25. Philosophy of Chromosome growth in CELL/ATOM?....

It is focused that the philosophy of origin and Chromosome level growth of **“Life/Molecule”** shall be narred as below. It is hypothesized that the first Life and first Molecule might have **3 Chromosome**.

Further during the course of time in the expanding Universe with respect to **“Space and Time”** various life / matter with various Chromosome level might

be developed gradually in “**ascending order**” evolution of Various new life organisms and Various new Molecules.

26. Philosophy of “TRIBE”?....

In human Anthropological Science that word “**Tribe**” is referred to indicate the particular **Race** of human (or) **Society**.

It is hypothesized that the philosophy of **TRIBE** shall be primarily referred to “**Three-in-one**” region of Electromagnetic Spectrum (ie) **UV region, Visible region, IR region**. The three different regions of **TRIBE** shall be indicated as below.

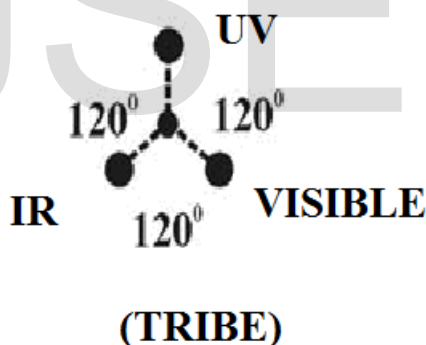

It is focused that the EMR shall be considered originated in **Region III of Universe**. The Region III of Universe shall be called as “**EINSTEIN REGION**”.

It is further focused the EMR region shall considered as **Material Universe** where all matter including Various Planets exist. The Material Universe shall be dived into three main region. (ie) **UV, Visible, IR**. The characteristics of three sub regions of Region III shall be indicated as below. The

origin of Ist human shall be considered evolved in “Ist Sub region”. The modern human shall be considered evolved in 3rd sub region.

S.No	Region	Radiation	Particle Property	Speed of Light
1.	Sub region 1	EMR I	Proton, Electron, Proton having negligible Mass.	Absolute light speed.
2.	Sub region 2	EMR II	Proton, Electron, Proton having considerable Mass.	Less than Absolute speed.
3.	Sub region 3	EMR III	Proton, Electron, Proton having higher Mass	Still less speed.

27. Anh Organism having Similar Chromosome?

It is hypothesised that EMR Spectrum (TRIBE) in Region III of universe emanating **Billions of Billions** rays. Each ray shall be considered as its having **Own Chromosome** Value. No ray shall be having similar Chromosome level. It is hypothesised that Billions of life organisms existing in Region III shall be governed by independent ray of Spectrum.

“Every human in the world having different Chromosome level identified by its own colour. No human is having Similar Chromosome”.

“Different human skin colour, eye Iris, Nose Structure, Hair Style shall be due to influence of different EMR Ray of different “Spectral region”.

- Author

28. Philosophy of "J" Chromosome human origin?

The first human shall be considered evolved spontaneously due to impact of Electromagnetic radiation from **Nuclide acid, Amino acid**. The first human had only three Chromosome called "**J- Chromosome**".

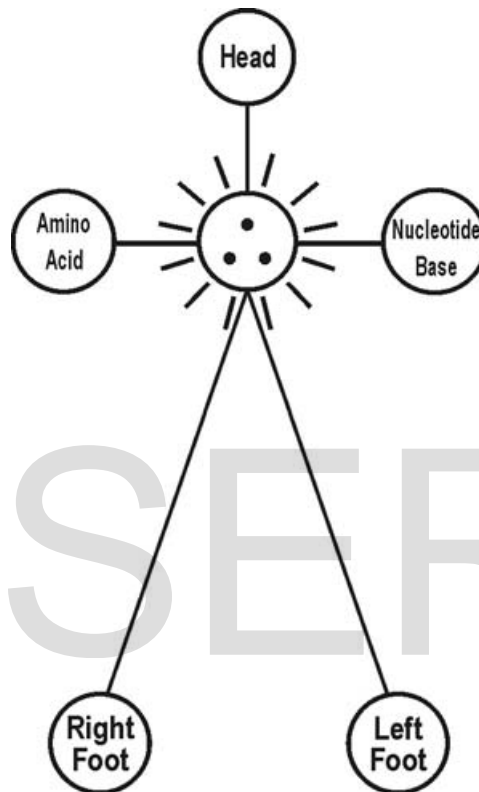

(AL-J)

The bottom Two dot shall be considered as "**Nuclie**" of the cell comprising **DNA** and **PROTEIN**. The centre dot shall be considered as **RNA** molecule of the cell.

Further the bottom **two dot** shall be considered as connected to same "**Horizontal axis**" called as **Auto some**. The centre dot shall considered as

“**Vertical axis**” connected exactly at **middle point** to the horizontal axis. The centre **Single dot** shall be considered as “**SEX CHROMOSOME**”.

It is focused that the configuration of Alphabet “**J**” might be derived from the configuration of three tiny dot “**Akkie Code**”.

29. Philosophy of Heart Structure?

It is focused that the existence of heart within every human shall be considered as tiny **COSMO UNIVERSE** i.e. the heart is composed of two parameter Cosmo and Universe.

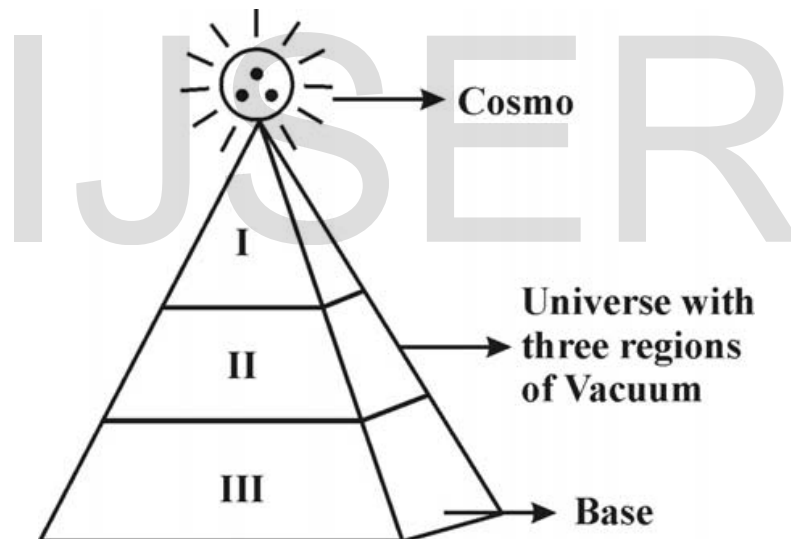

(MODEL HEAR STRUCTURE)

The shape of heart shall be considered like three dimensional structure in which Cosmo shall be considered as neutrino energy source which derives energy from natural neutrino radiation. The Universe shall be considered as

HUMAN BRAIN comprising of **THREE-IN-ONE** segment of RNA, POROTIEN, DNA CODE.

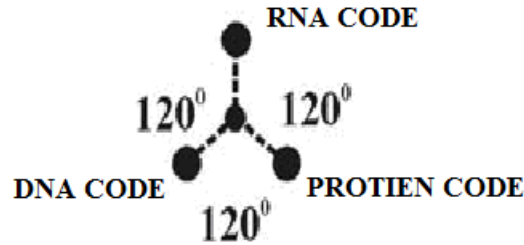

(HUMAN BRAIN)

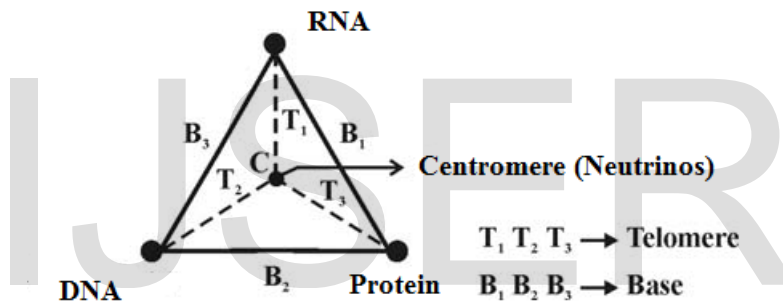

(TOP VIEW)

30. Philosophy of Gender Status of "J" Chromosome?

It is hypothesized that the J chromosome shall mean three chromosome on origin of life i.e. two numbers autosome and one number sex chromosome. The hypothetical structure of three chromosome shall be indicated as below:

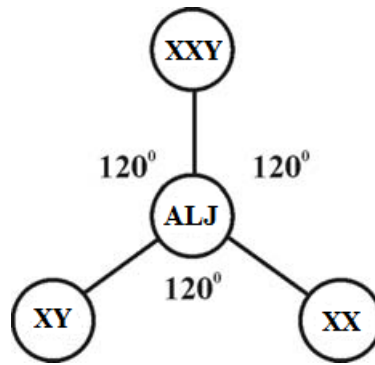

"J" chromosome shall be considered as "Third Gender". "AL-J" human origin shall be considered as "Godly" Person and Black Beauty "Angel".

- Author

31. Philosophy of "XX", "XY" Chromosome?

It is focused that there is no current for adoption of "XX", "XY" symbol for Female, male human Chromosome.

It is hypothesized that the philosophy of "Y" chromosome symbol adopted for male. Identify might be derived from the philosophy of Human cell "STAR POINT" connectivity to star point of "NEUTRINO RADIATION".

"The Philosophy of "J" symbol for Chromosome might be derived form the philosophy of "Star Point" in Prehistoric time"

- Author

It is hypothesized that the philosophy of "XX" chromosome symbol adopted for Female identify might be derived from the philosophy of **Star Point** connectivity.

(1)

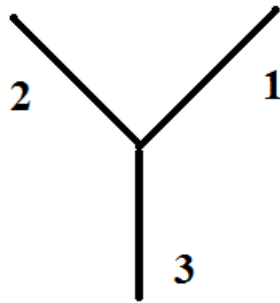

(Ist Stage)

(2)

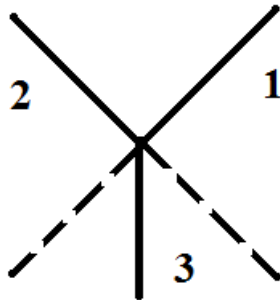

(IInd Stage)

(3)

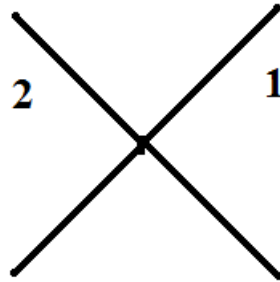

(IIIrd Stage)

In the above symbol segment 1,2 shall be considered as **Autosome** and segment 3 shall be considered as **“Sex Chromosome”**.

During the course of time the **Segment 3** shall be considered **Split** into **Two** and become Shape like **“X”**.

“Human populations shall be considered as having three genders rather than Two.

- (a) **XXY - Third Gender.**
- (b) **XY - Male Gender**
- (c) **XX - Female Gender**

The “Third Gender” human shall be defined within the following scope.

1. Third Gender human shall be considered as **“origin of Life”** and called as **“J” Chromosome Human.**

2. Third Gender human had been **“Spontaneously”** evolved due to impact of Electromagnetic Radiation.

3. Third Gender human had only **“Three Chromosome”**.

4. Third Gender human shall be considered as **"Godly"** person.
5. Third Gender human shall be considered as **Ancestor** to modern human.
6. Third Gender human shall be considered as having different genetic characteristics and capable of **"FLYING"**.
7. Third Gender human shall be considered evolved without involvement in **"SEX"**.
8. Third Gender human shall be considered not taking good like **SAMBAR, RASAM**. They could live and survive with **Sweet Words, Sweet Thoughts, Sweet Dreams**.
9. Third Gender human shall be considered breath **"OZONE"**.
10. Third Gender human **Blood** shall be considered as more **Acid**.

32. "AL-J" human is a cloning Person?

The Principle of cloning is the process of creating an identical copy of something. In Biology it collectively refers to process used to create copies of DNA fragments (molecular cloning), cells (Cell cloning) of organisms. The term also encompasses situation whereby organisms reproduce **"Asexually"**.

Molecular cloning refers to procedure of isolating desired DNA sequence and obtaining multiple copies of it in vivo. Cloning is frequently employed to amplify DNA fragments containing genes but it can be used to amplify any DNA sequence such as promoters won coding sequence are randomly fragmented DNA.

33. What is the first Atom evolved?.....

It is hypothesized that Hydron shall be considered as the origin, centromere of chemical universe. The element **Carbon, Nitrogen, Ozone** shall be considered as the three fundamental species to "Hydrogen". All other elements including **Oxygen** shall be considered as **sub-species** elements to the **Carbon, Nitrogen, Ozone**. Oxygen shall be considered as species to **Ozone** evolved from Ozone at much later period after origin of "**First human**".

"J.Chromosome human population could breath "Ozone" The blood might be more acidic" - Author

The fundamental elements carbon, Nitrogen, Ozone shall be considered as responsible for evolution of three types of Magnetic field (i.e) **Ferromagnetic, Diamagnetic, Paramagnetic** required for cell growth during origin of J-Chromosome human.

(1)

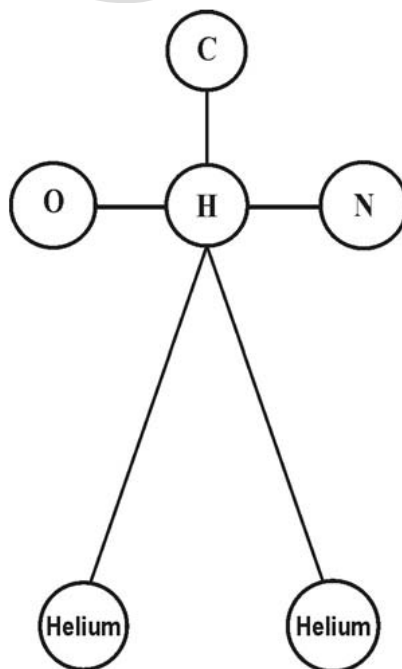

(Fundamental Organic Elements)

(2)

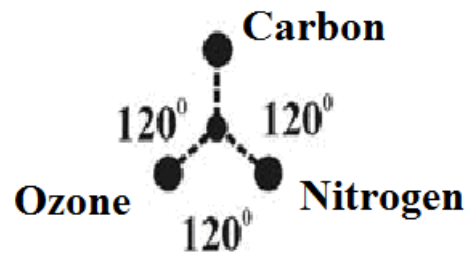

(Chemical Oscillation)

34. Radiation is matter?

It is focused that there are different types of **Radiations** exist in the Universe Antineutrino radiation, Neutrino radiation, Electromagnetic radiation shall be considered as the three fundamental radiations of the Universe, Alpha, Beta, Gamma and other types of radiations shall be considered as **Species, Sub species** radiations to the three fundamental radiations.

Current theories focus matter exist in three state (i.e) solid state, liquid state, Gaseous state. There is no classification for **Radiation**.

“It is hypothesized that Radiation shall be also considered as Type of matter. The smallest unit of Radiation shall be considered as “RAY” which is composed of Three-in-one Neutrinos Photon, Electron, Proton. It may be antimatter radiation, neutrino radiation, electromagnetic radiation, other Cosmic radiation. Particles never exists alone.

- Author

35. What is Life?

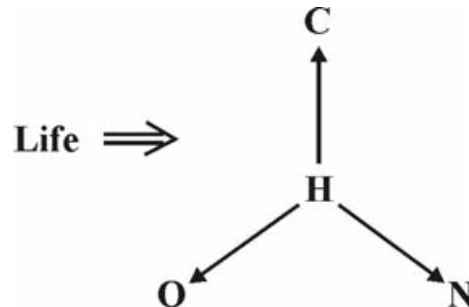

**“LIFE SHALL BE DEFINED AS THE BYPRODUCT OF
FUNDAMENTAL NEUTRINOS (STAR DUST)” - Author**

36. Male Human Nipples have any Specific function?

There are so many hypothesis about the logical existence of **Male human nipples.**

It is hypothesized that **Human two Nipples, Human NAVEL** shall be considered as the **THREE-IN-ONE** Principal **“Electromagnetic Sensors”** which links Human Heart to **star point** Neutrino radiation for deriving energy for function of **Heart**. The **THREE-IN-ONE** sensors shall also be called as naturally embossed universal **J-code**. Heart tissues shall be considered containing special type of **cells** to derive energy for its function. Nipples, Navel act as a **gateway** to transmit Neutrino energy through Nervous system as **“Electric Pulses”** to the **cells of Heart**.

(1)

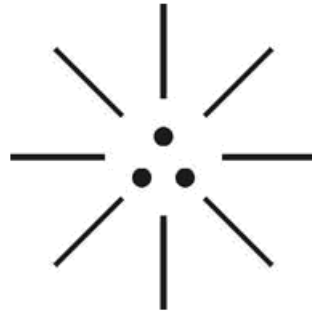

(J - Code)

(2)

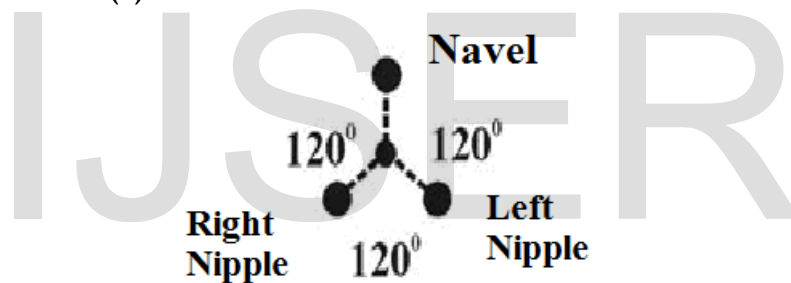

(THREE-IN-ONE SENSOR)

The right dot shall be considered as the right nipple associated to **Proton** for cells functional part, the left dot shall be considered as the left nipple associated to **Electron** for cells structural part, the centre dot shall be considered as the “**NAVEL**” associated with **photon** for cells law part (genome).

It is hypothesised that the Variation **Heart Beat** is closely associated with the three “**SENSORS**” for regulations of “**Heart Beat**” to the normal level.

“Any surgical attempt to remove Nipples, Navel may seriously affect the regulation of “Heart Beat” and effective sequential functions of “CELLS”. Every human shall be considered controlled by Neutrino radiation “RAY”. Each RAY shall be considered as a “MSC”. Human shall be considered as BASE TOWER. Heart shall be considered a BTS. Equipment accessed through “SENSORS”.

-Author

Further Any variation in property of Electromagnetic radiation may also effect the **“Normal pulse rate”** of Heart. It is hypothesised that the **“J-Chromosome”** human had Heart normal pulse rate around **“60 per minute”** in Prehistoric time. During the course of time the human normal pulse rate might be gradually **“reset”** to different value and might be attained to the stage of **“72 per minute”** in modern time.

37. Philosophy of Godly Particles?

It is focused that the fundamental **THREE-IN-ONE** neutrinos **PHOTON**, **ELECTRON**, **PROTON** shall be called as godly particles which are responsible for evolution of all matters including planets of the Universe, **Origin of First Life.**

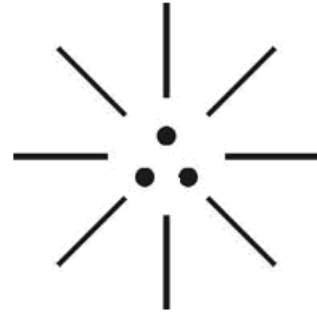

(Godly Particles)

The Godly particles shall be considered as responsible for origin of **THREE-IN-ONE** macro molecules (DNA, Protein, RNA) and origin of first life.

38. Philosophy of Origin of First Human AL-J?

The origin of first human AL-J had only three chromosome (**Trisomy**) derived from Trisomy Cell (PROTEIN), Trisomy ATOM, DNA, Trisomy EMR (RNA). The philosophy of Trisomy atom, Trisomy cell, Trisomy EMR shall be considered as composed of particles with **ZERO MASS** in the **early Universe**.

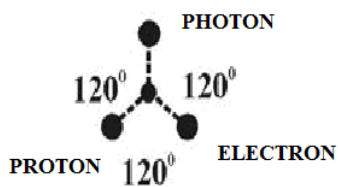

(Trisomy EMR)

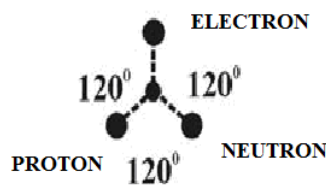

(Trisomy Atom)

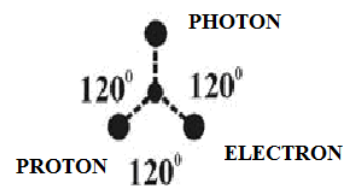

(Trisomy Cell)

The Trisomy human shall be considered as the origin of first life. It is hypothesized that every life organism and its species have Trisomy chromosome as a centromere in the genetic system. The rarely occurrence of Trisomy 13, Trisomy 18, Trisomy 21 shall be considered not as the down syndrome but as the genetic reflection of Trisomy origin of life.

39. Apes Have Down Syndrome?

It is focused that Trisomy occurs not only in human but also in apes, all life organisms including plants. Case study shows that (D WAAL, YERKES, PRIMATE Center of Emory University) occurrence of Trisomy in chromosome 22 in one Chimpanzee and one Orangutan; in both, the condition was associated with mental retardation superficially resembling down syndrome.

40. Hydrogen is Trisomy Atom?

It is focused that in Atomic model hydrogen is considered as an Atom having nuclei with only proton surrounded by one electron.

It is hypothesized by the author that any Atom shall be considered as having **THREE-IN-ONE** fundamental sub particle i.e. Proton, Neutron, Electron. It is focused that hydrogen shall be considered as **TRISOMY ATOM** comprising of three fundamental sub particles **with zero mass**.

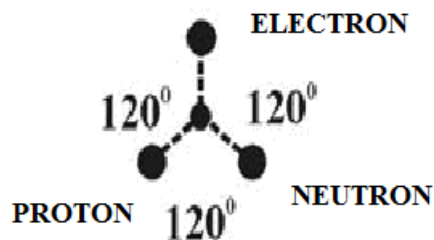

(Trisomy Atom)

It is hypothesized that hydrogen shall be considered as Trisomy atom rather mere atom and considered as centromere of material universe. All the

subsequent atoms shall be considered as species to hydrogen trisomy atom having fundamental sub particles proton, neutron, electron with **VARIED MASS**. Further formation of chemical elements such as carbon 12, carbon 14, other isotopes, isobars, isotones, isomers shall be considered as evolved due to genetic reflection of Trisomy hydrogen.

41. Hybrid is a Cloning matter?

It is focused that manipulation of hybrid variety in the original animal cell, plant cell shall be considered as artificial formation of **CLONING MATTER**.

42. Philosophy of Real and Image?

It is focused that super nature shall be considered as **REAL** human and modern human shall be considered as **IMAGE** of super nature further the **real** shall be considered as dark radiation and **image** shall be considered as white radiation.

(a)

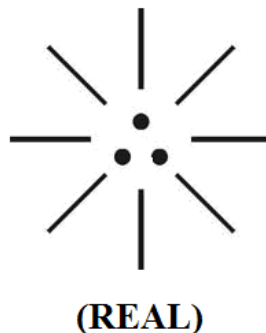

(b)

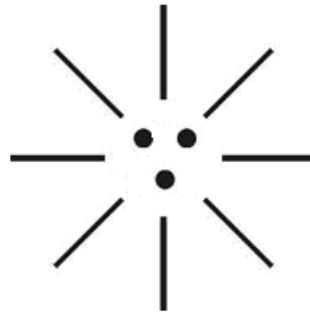

(IMAGE)

43. Philosophy of Material Universe?

It is focused that the region-III of Universe shall be considered as material universe where all matter exists including planets. The MARS planet shall be considered as the first evolved planet in the Universe and considered as **MOTHER** of all planets. **SUN, EARTH, MOON** shall be considered as three fundamental species planet to the MARS planet which acts as **BASE** of Cosmo Universe. The relative position of SUN, EARTH, MOON shall be hypothetically indicated as below. The Earth and Moon shall be located in horizontal axis and Sun is located as vertical axis exactly perpendicular to horizontal axis.

(a)

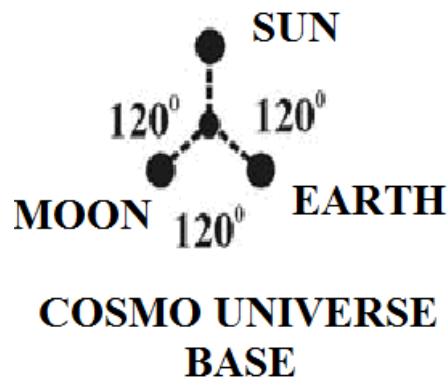

(b)

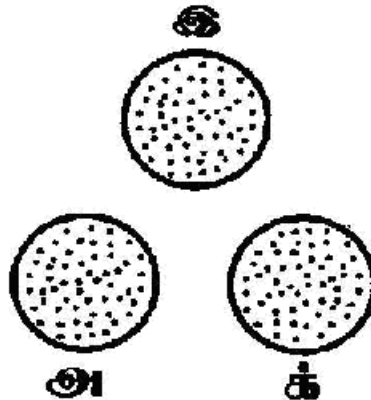

(SUB SPECIES PLANET)

"The whole Cosmo Universe consists of only one Sun, one Earth, one Moon. Further the whole Cosmo Universe shall be considered as single planetary system centered by MARS PLANET".

-Author

44. Einstein Sir is Wrong?

"It is hypothesised that Einestein Sir may not be wrong!. **Light, Lightning** shall be considered as **species** to Electromagnetic Radiation. Electromagnetic radiation can travel at absolute speed of light. Light Ray Particle, shall be considered as having "**higher mass**" compared to Electromagnetic radiation particle. Einstein Sir observed focused in his theory may be **LIGHT** not Electromagnetic Radiation which exist in the upper region of **Region III** Universe. **Tesla Sir** focused about "**Aether Energy**" may be closely associated with **neutrino radiation** which probably travels much faster than speed of **Light** and electromagnetic radiation because of its **zero mass**.

"Aether exists. Einstein sir can't dispute to Tesla sir!"

- Author

45. Darwin Sir is Wrong?

Darwin sir may not be wrong!. He probably may not be conscious about "J" Chromosome Human" who is Godly Person. Darwin Sir probably "Athiest" and hided the mystery about J chromosome human.

46. Philosophy of Philosopher, Scientist, Engineer,

Technocrat?
IJSER

(a)



(Philosopher)

(b)

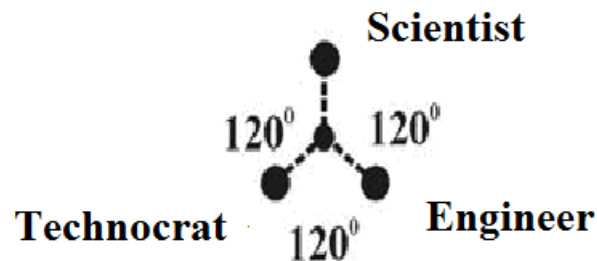

(TRINITY PERSON)

47. Philosophy about Tesla, Darwin, Einstein?

In Cosmological Theory Tesla, Darwin, Einstein shall be considered as fundamental **THREE-IN-ONE** parameter in making of the Universe. All other personalities and their theories shall be considered as sub species to fundamental parameter. Further in Cosmological angle Tesla shall be considered as **THEIST**, Darwin shall be considered as **ATHEIST** and Einstein shall be considered as **ETHIST**.

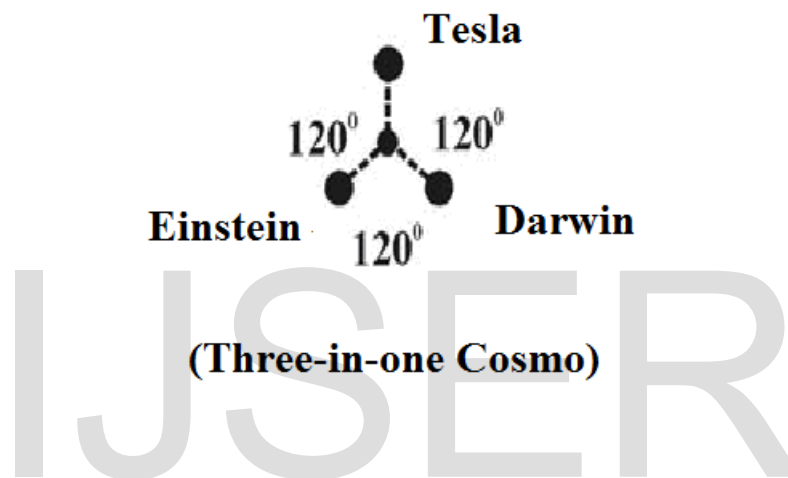

Further in Cosmo Universe Tesla shall be considered as dark law, Darwin shall be considered as dark energy, Einstein shall be considered as dark matter.

48. Case study on Biblical Narration

It is hypothesized that the **Angel** populations stipulated might belong to "**J-Chromosome**" human. The Angels might have had only **3 Chromosome** and capable of **Flying**. Angels are sometime depicted with white skin. It is focused that Angels shall be considered as "**Black Beauty**" and Third Gender Godly population. Further Angles shall be considered **ancestors** to "**Adam, Eve**" populations. The Adam populations shall be considered as **species** descended

form **Angels** and started living on **Earth Planet** at later period. Further the Adam sons **CAIN, SETH** might have married **Angels (Gen 4:17)**

49. Philosophy of Number "786" in Islamic culture?

Case study shows that the number "786" is associated with complicated Islamic "Numerology". It is traced to ancient Civilisation of **Egypt, Babylon, Assyria, Greece, India**. The art of 'Numerology' is felt further linked with development of **Mathematics, Geometry, Trigonometry**.

Some belief shows that the number 786 is associated with the phrase "**Bismilah hir Raheman Nir Raheem**". In Islamic Culture Muslims used to begin anything with saying or writing the **above phrase**. It is believed that the number 786 related to total words in the above names

- a) "**BISMILAH**" - "8"
- b) "**RAHEMAN**" - "7"
- c) "**RAHEEM**" - "6"

It is focused that the philosophy of 786 ISLAMIC Culture might be derived from the Philosophy of Prehistoric Tamil "**AKKIE CODE**" Culture. The Prehistoric Tamil population were expert in **Astro-physics, Astronomy**, and formulated three fundamental **Neutrinos** of universe formulated with three tiny dot called **Akkie Code**, i.e.. the "**Three-in-one**" fundamental **Neutrinos** of universe with three tiny dot called **Akkie Code**. The "**three-in-one**" fundamental Neutrinos **Photon, Electron, Proton** shall also be called as "**GOD PARTICLES**". "**Akkie**" shall mean **Dark Radiation, Star particles**.

a)

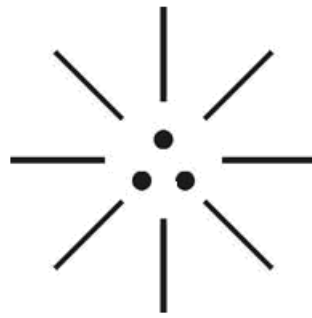

(AKKIE)

b)



(786)

The three-in-one fundamental neutrinos has three-in-one **ethnic characteristics** which shall be represented as below.

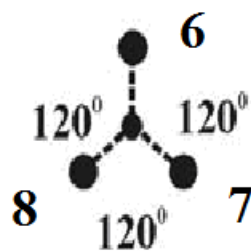

(AKKIE)

- a) Photon Neutrino - "6"
- b) Electron Neutrino - "7"
- c) Proton Neutrino - "8"

Further the prehistoric Tamil populations formulated that the whole Cosmo Universe shall be considered as closed "TRIPOD" structure having "TRIANGULAR BASE" composed of SUN, EARTH, MOON in THREE-IN-ONE structure. In prehistoric Tamil, the Cosmo Universe shall be called as "AKKILEM" which comprised of **three-in-one** regions. Each region shall be considered as having different **physical, chemical, Mathematical properties**.

a)



b)

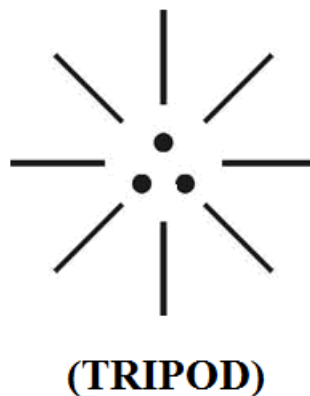

Further, the **SUN, EARTH, MOON** shall be considered as having different characteristics derived from **Photon, Electron, Proton Neutrinos**.

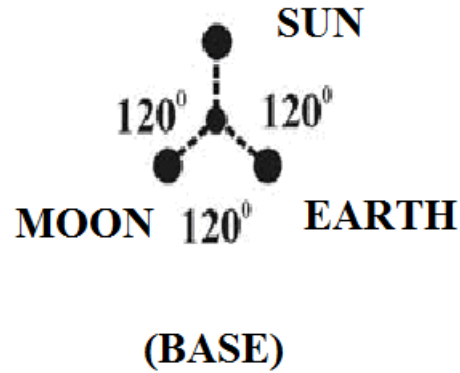

- a) **SUN** - **Photon** characteristics (6)
- b) **EARTH** - **Electron** characteristics (7)
- c) **MOON** - **Proton** characteristics (8)

It is hypthesised that the philosophy of "786" might be derived from the philosophy of **three-in-one regions** of Cosmo Universe during the course of **Space and Time** as indicated below.

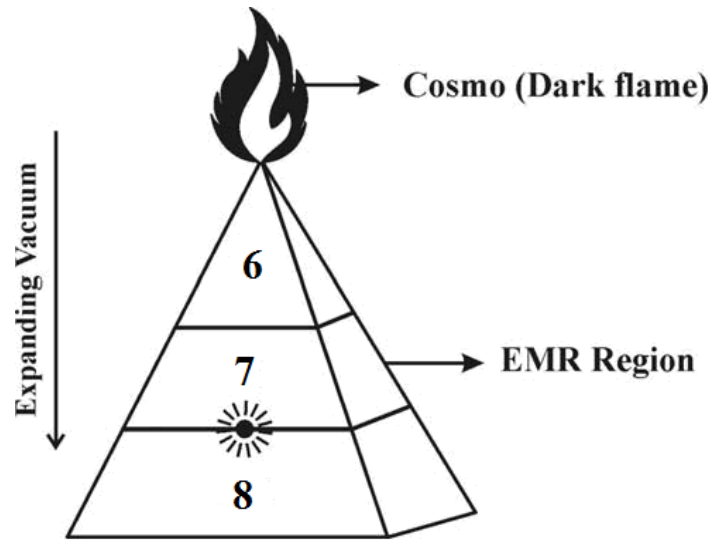

(MODEL COSMO UNIVERSE)

- a) Region I - "6" (Anti-neutrino radiation)
- b) Region II - "7" (Neutrino radiation)
- c) Region III - "8" ((Electromagnetic radiation)

Further, the number "786" shall be considered as **three-in-one** ethnic regions of universe. The three ethnic regions shall also be called as **ATHI(6), AKKIE(7), ETHI(8)**.

a)

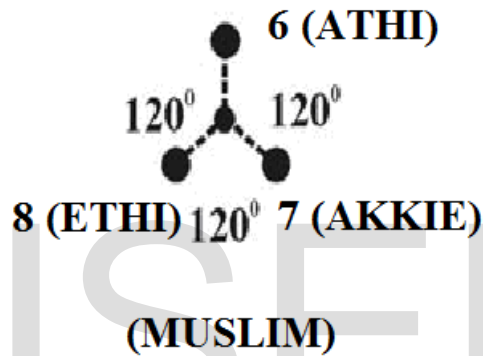

b)

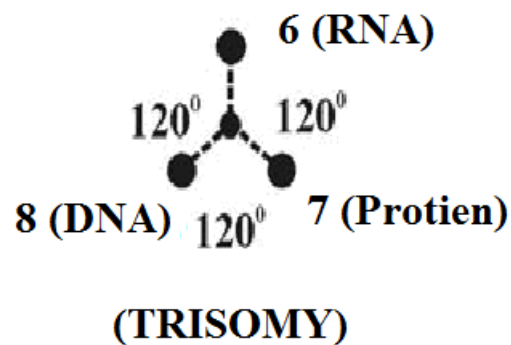

In medical term the number "786" shall be considered as **TRISOMY** as noted below.

- a) "6" - "RNA (First Chromosome)"
- b) "7" - "PROTEIN (Second Chromosome)"
- c) "8" - "DNA (Third Chromosome)"

- Author

50. Conclusion:

The modern human had four type of Blood group (i.e) **AB, A,B,O**. It is focused that all the four type of Blood might be evolved in different phases during the course of **space and time** in the expanding Universe. There is no current theory about Origin of first blood group and Lineage of other blood groups. It is focused that Angels might have had only single type blood **AB** which is called as **Universal acceptor**. Further in the evolutionary concept Male, Female gender human might have descended from **Third Gender** Angel Populations.

51. Reference

- [1] Intensive Internet "e-book" study through, Google search and wikipedia
- [2] M.Arulmani, "3G Akkanna Man", Annai Publications, Cholapuram, 2011
- [3] M. Arulmani; V.R. Hemalatha, "Tamil the Law of Universe", Annai Publications, Cholapuram, 2012
- [4] Harold Koontz, Heinz Weihriah, "Essentials of management", Tata McGraw-Hill publications, 2005
- [5] M. Arulmani; V.R. Hemalatha, "First Music and First Music Alphabet", Annai Publications, Cholapuram, 2012
- [6] King James Version, "Holy Bible"

- [7] S.A. Perumal, "Human Evolution History"
- [8] "English Dictionary", Oxford Publications
- [9] Sho. Devaneyapavanar, "Tamil first mother language", Chennai, 2009
- [10] Tamilannal, "Tholkoppiar", Chennai, 2007
- [11] "Tamil to English Dictionary", Suravin Publication, 2009
- [12] "Text Material for E5 to E6 upgradaton", BSNL Publication, 2012
- [13] A. Nakkiran, "Dravidian mother", Chennai, 2007
- [14] Dr. M. Karunanidhi, "Thirukkural Translation", 2010
- [15] "Manorama Tell me why periodicals", M.M. Publication Ltd., Kottayam, 2009
- [16] V.R. Hemalatha, "A Global level peace tourism to Veilankanni", Annai Publications, Cholapuram, 2007
- [17] Prof. Ganapathi Pillai, "Sri Lankan Tamil History", 2004
- [18] Dr. K.K. Pillai, "South Indian History", 2006
- [19] M. Varadharajan, "Language History", Chennai, 2009
- [20] Fr. Y.S. Yagoo, "Western Sun", 2008
- [21] Gopal Chettiar, "Adi Dravidian Origin History", 2004
- [22] M. Arulmani; V.R. Hemalatha, "Ezhem Nadu My Dream" - (2 Parts), Annai Publications, Cholapuram, 2010
- [23] M. Arulmani; V.R. Hemalatha, "The Super Scientist of Climate Control", Annai Publications, Cholapuram, 2013, pp 1-3